

Montage Handleiding Serie ST01M

Inloopdouche Serie ST01M(Stabilisatiestang)

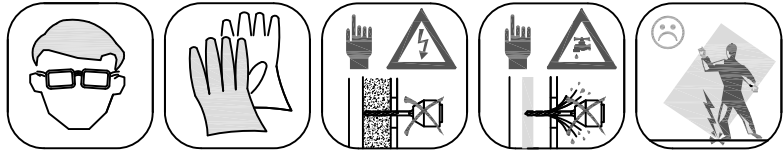

VAN RIJN PRODUCTS



Wij danken u voor uw keuze voor één van onze doucheopstellingen en we wensen u veel plezier met uw aankoop. Lees de instructies aandachtig door voordat u begint met de montage. Niet juist naleven van de instructies kan de garantie doen vervallen.

BELANGRIJKE MEDEDELING

Controleer de inhoud van de verpakking op eventuele transportschade en kijk of alle onderdelen aanwezig zijn.

Zet het glas tijdens het uitpakken nooit direct op de grond, gebruik altijd karton of een vergelijkbaar materiaal als ondergrond. Wees voorzichtig bij het verplaatsten, let hierbij vooral op de hoeken en randen van het glas.

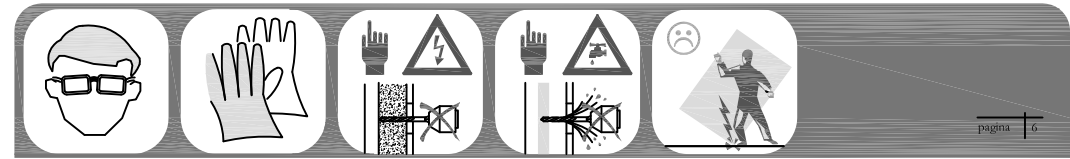
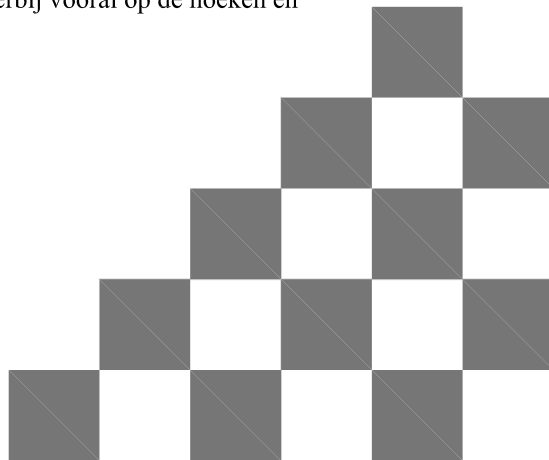

INSTRUCTIE VOOR GOED GEBRUIK EN ONDERHOUD

De douchewand moet na elk gebruik schoon gemaakt worden. Gebruik hierbij geen chemische middelen, maar een zachte doek of wisser. Gebruik nooit schuurmiddelen.

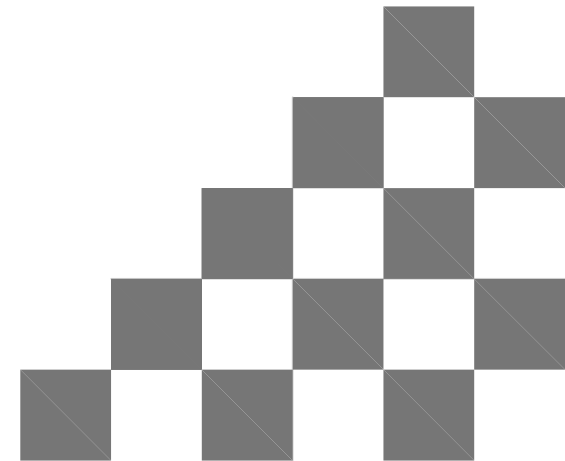

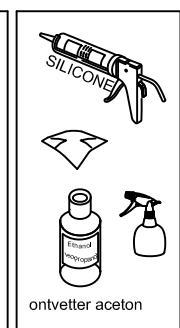
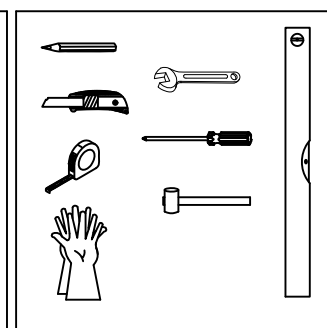
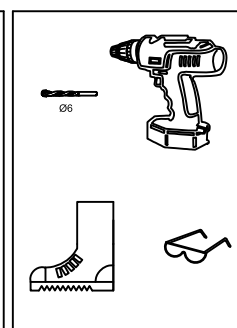
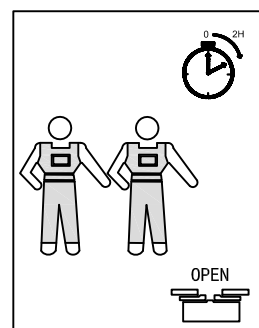
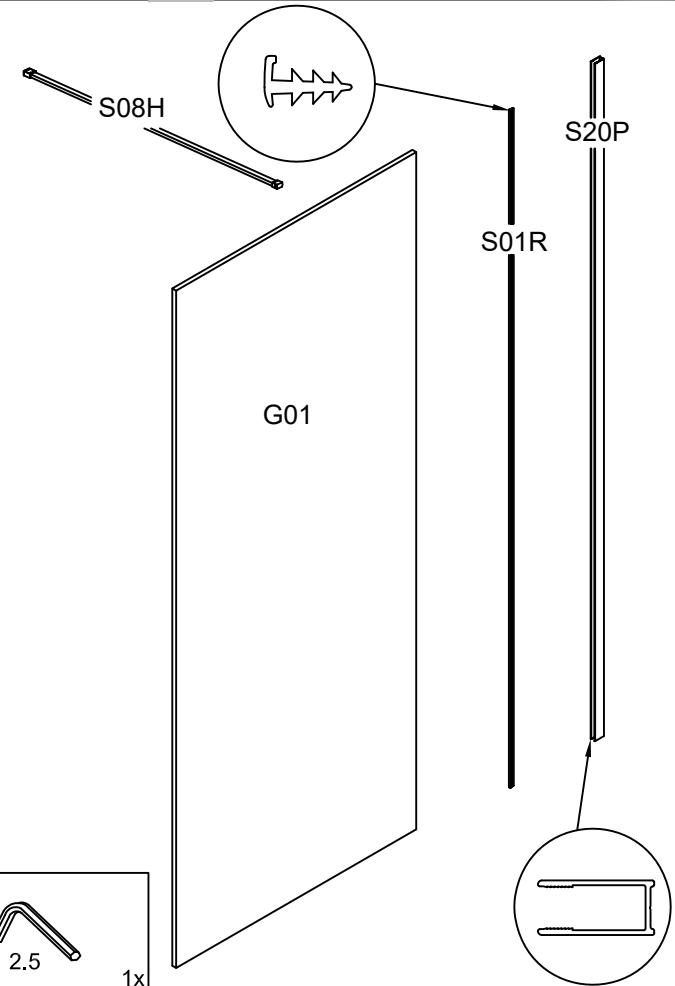
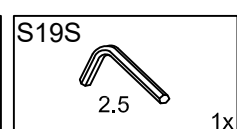
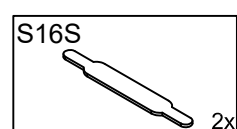
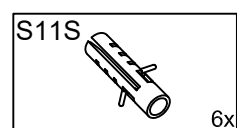
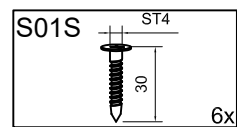
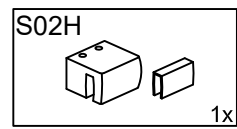
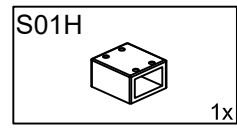
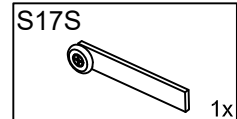
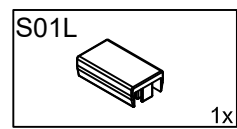
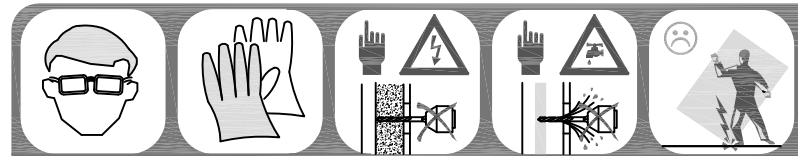
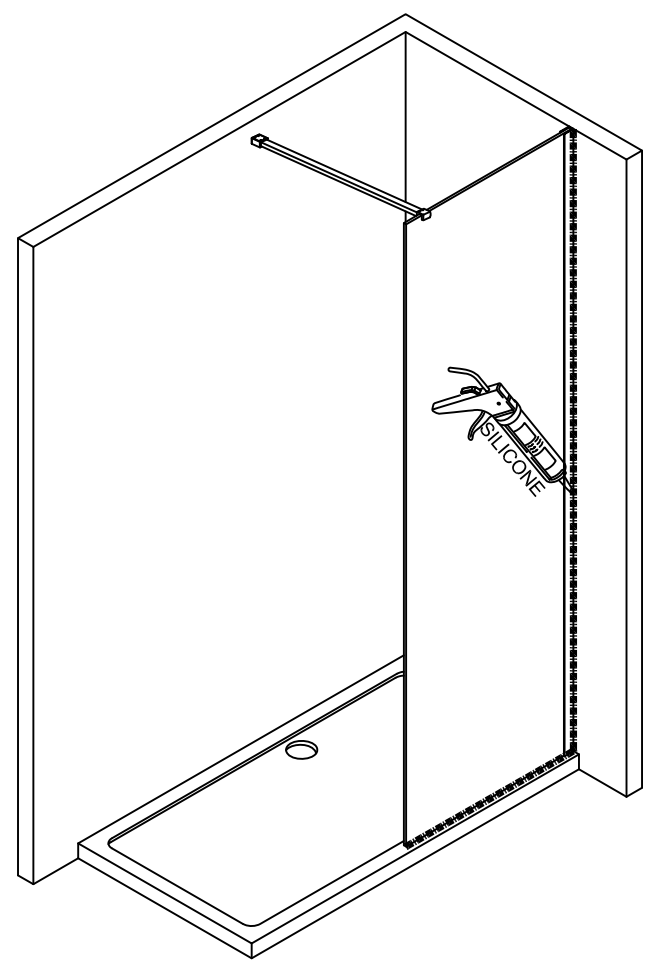
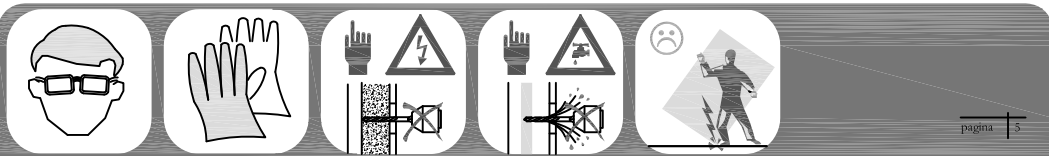

ontvetter aceton

