

MIAMI

Dit hoogglans witte acryl bad heeft een ligzijde en een afgerond voeteneind. De rugvorm is in twee richtingen afgerond, waardoor een comfortabele ligvorm is ontstaan. Het bad is symmetrisch, dus in een rechter en een linker hoek te plaatsen.



Riho acryl baden zijn gemaakt van hoogwaardig acryl, versterkt en door en door wit van kleur. De acryl baden zijn UV-bestendig. Het materiaal is volledig poriënvrij. Kalk hecht slecht waardoor er geen bacteriën achterblijven. Daarom zijn de baden gemakkelijk schoon te maken. Het oppervlak is aangenaam warm. Standaard bevat het bad geen potenset en overloop/afvoer.

Artikelnr.	L x W x H (cm)	Volume* (ltr)	Gewicht (kg)	Water hoogte (cm)	Optie Rihopool**
BB58005	150 x 70 x 43	80	15	35	Air / Flow
BB60005	160 x 70 x 43	90	18	35	Air / Flow
BB62005	170 x 70 x 43	105	20	35	Air / Flow
BB64005	180 x 80 x 43	140	23	35	Air / Flow

* Het volume van het bad is inclusief het gemiddelde volume van één persoon.

** Bij Rihopool whirlpoolsystemen is de pootset inbegrepen.

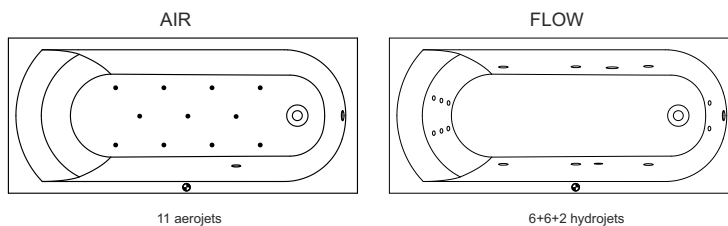

Additioneel aan te schaffen

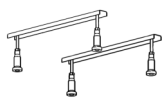

POOTSET01U

Bij whirlpools is de pootset inbegrepen!



Mc Alpine
060100210



Riho zwart
AT80100



Viega Multiplex
060100310



Viega Multiplex Trio
060100360

Optioneel aan te schaffen



Hoofdkussen
AH19110



Hoofdkussen
AH19115



Hoofdkussen
AH13110



Hoofdkussen
AH13115



Zie volgende
pagina

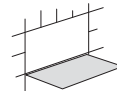

Inspectie luik
ZA11000000005

DOUCHESCHERM

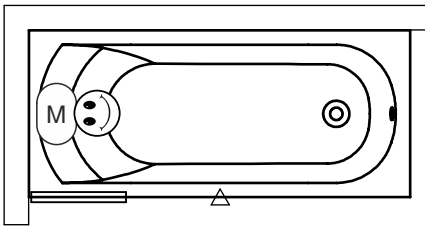

Scandic X107	Scandic X108	Scandic X109	Scandic X109V	Scandic X409	Scandic X500	Novik Z107	Novik Z500	Grid GB501	Lucid GD501
--------------	--------------	--------------	---------------	--------------	--------------	------------	------------	------------	-------------

Rechter type

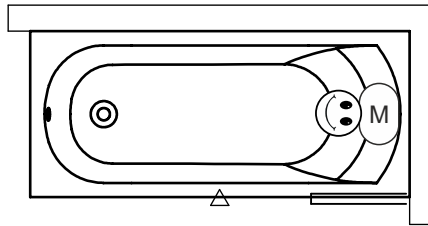

Linker type



-  Motor Hydro of Aero
-  Bediening
-  Service luik

BAD	Voor paneel	Zij paneel	Hoogte (cm)
BB58005	P150R05	P073N05	57
BB60005	P160R05	P073N05	57
BB62005	P170R05	P073N05	57
BB64005	P180R05	P083N05	57

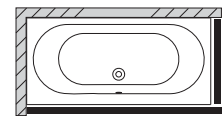
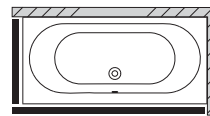
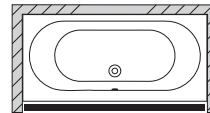

	A	B	C	D	E	F	G
BB58005	150	70	43	132	100	41,5	58
BB60005	160	70	43	142,5	110	41,5	58
BB62005	170	70	43	152,5	120	41,5	58
BB64005	180	80	43	162,5	130	41,5	68

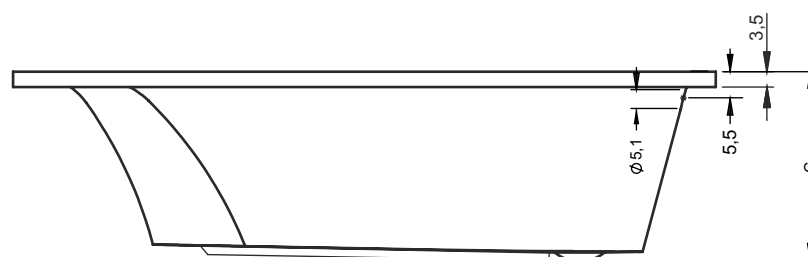
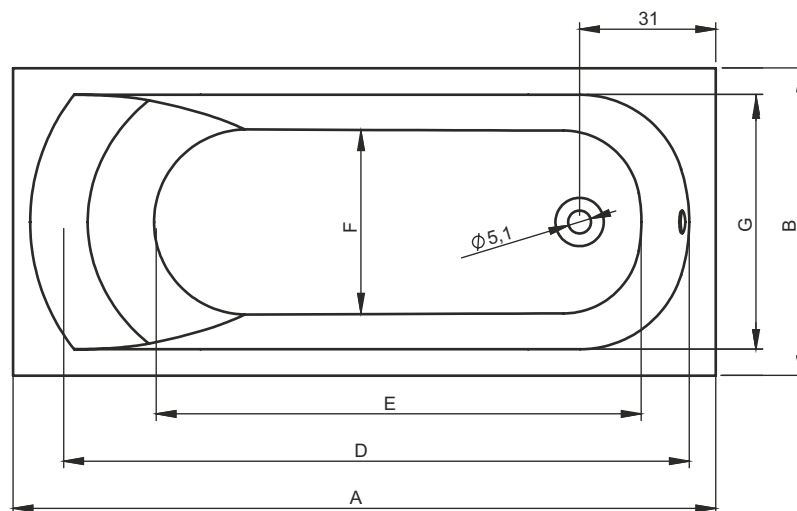

Data onder voorbehoud van wijzigingen