

Montage Handleiding
Serie ST04350

Hoekcabine Serie-ST04350

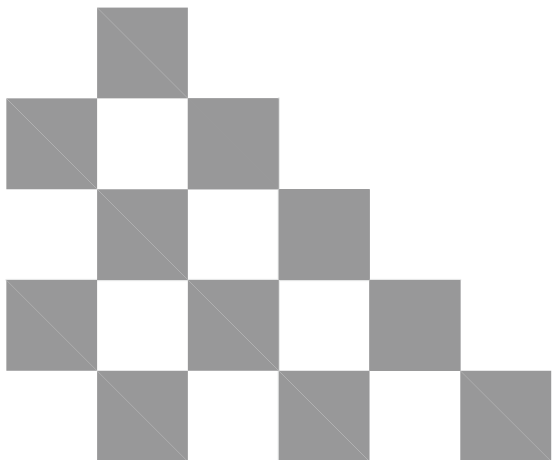

VAN RIJN PRODUCTS



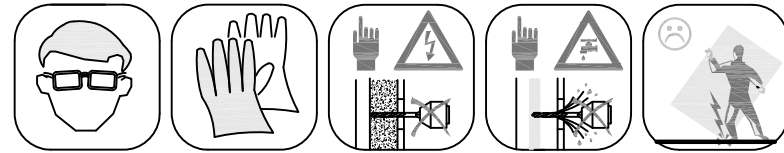

Wij danken u voor uw keuze voor één van onze doucheopstellingen en we wensen u veel plezier met uw aankoop. Lees de instructies aandachtig door voordat u begint met de montage. Niet juist naleven van de instructies kan de garantie doen vervallen.

BELANGRIJKE MEDEDELING

Controleer de inhoud van de verpakking op eventuele transportschade en kijk of alle onderdelen aanwezig zijn.

Zet het glas tijdens het uitpakken nooit direct op de grond, gebruik altijd karton of een vergelijkbaar materiaal als ondergrond. Wees voorzichtig bij het verplaatsten, let hierbij vooral op de hoeken en randen van het glas.

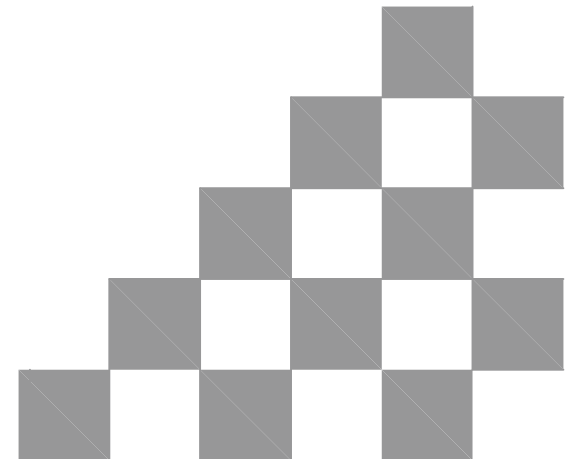

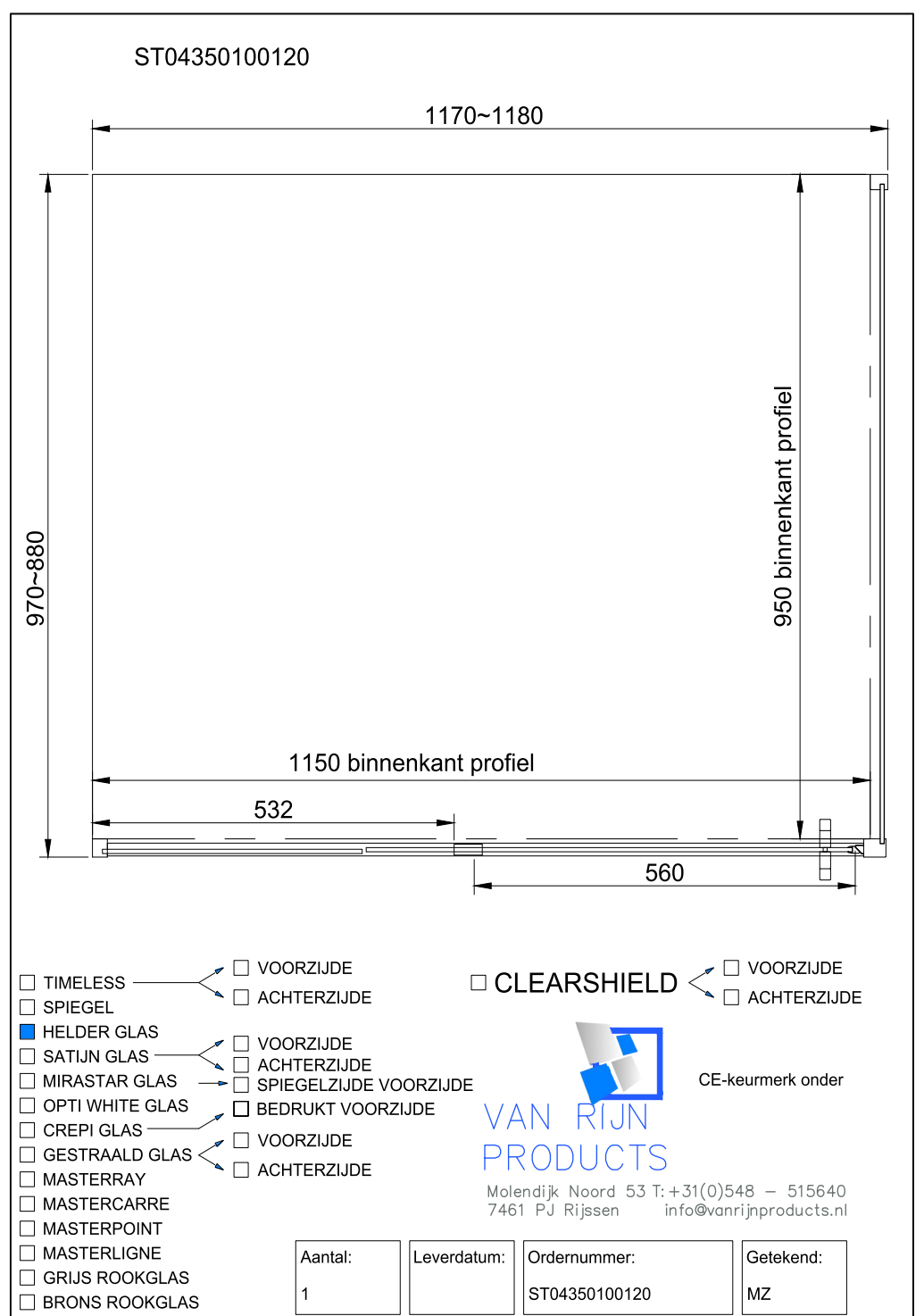
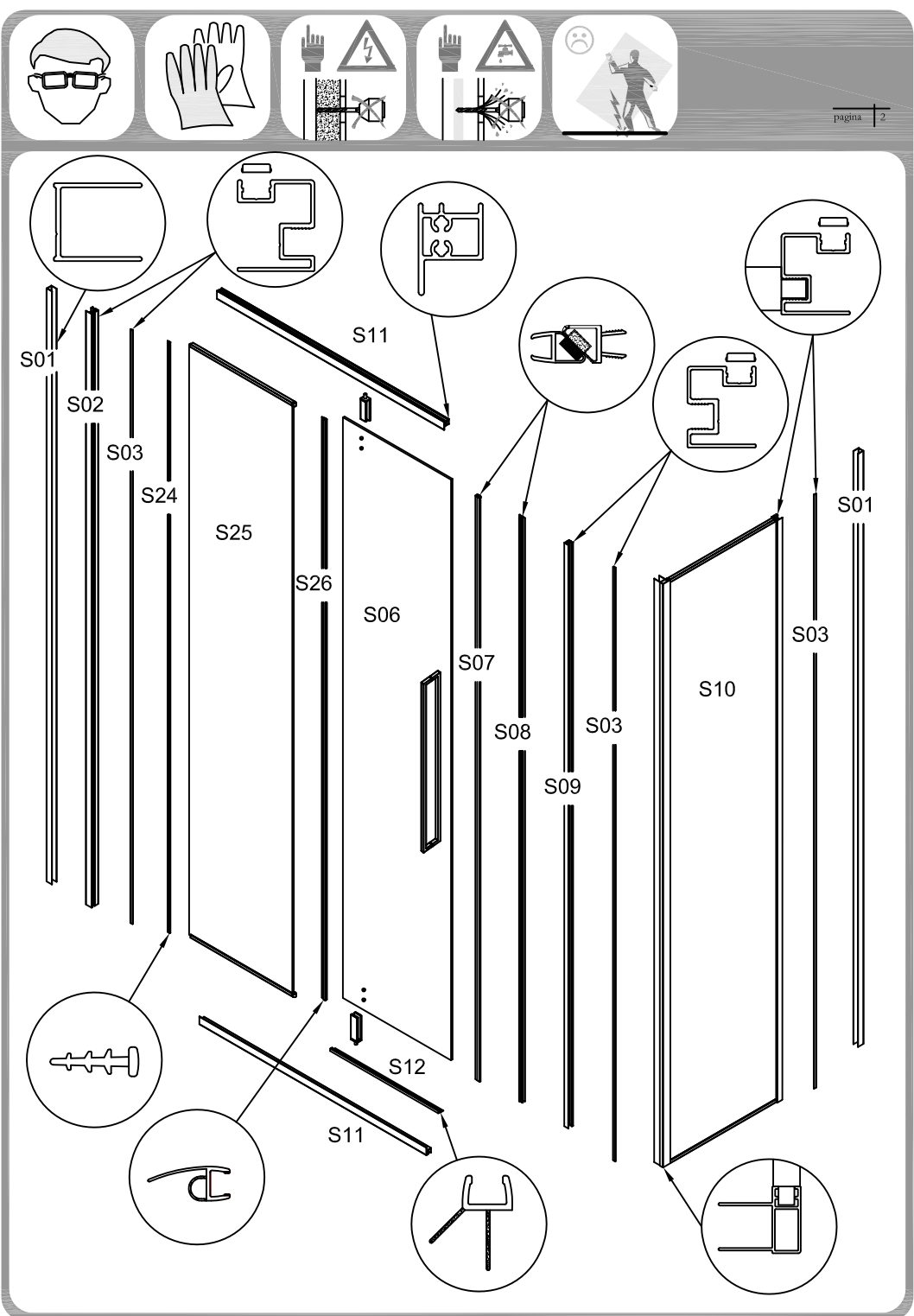

ST0435090120

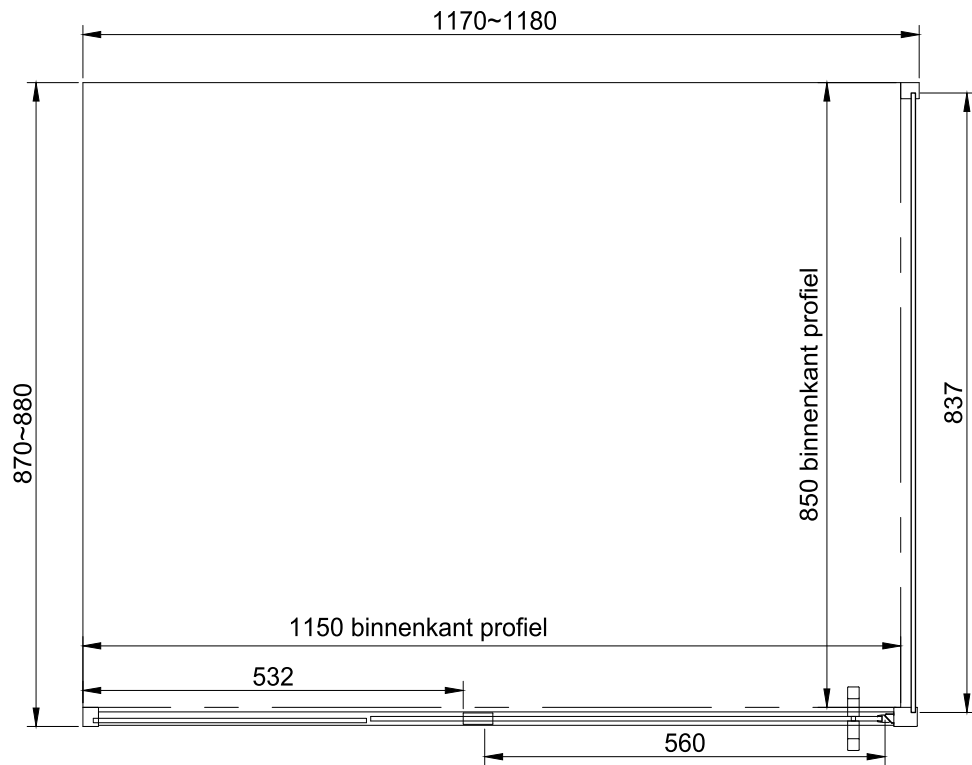

- TIMELESS
- SPIEGEL
- HELDER GLAS
- SATIJN GLAS
- MIRASTAR GLAS
- OPTI WHITE GLAS
- CREPI GLAS
- GESTRAALD GLAS
- MASTERRAY
- MASTERCARRE
- MASTERPOINT
- MASTERLIGNE
- GRIJS ROOKGLAS
- BRONS ROOKGLAS

- VOORZIJDE
- ACHTERZIJDE

- CLEARSHIELD
- VOORZIJDE
- ACHTERZIJDE



CE-keurmerk onder

Molendijk Noord 53 T: +31(0)548 - 515640
7461 PJ Rijssen info@vanrijnproducts.nl

Aantal:	Leverdatum:	Ordernummer:	Getekend:
1		ST0435090120	MZ

- Check BESLAGTYPE
- Check GLASTYPE
- Check GLASMAAT
- Check SCHUINING / SPARING

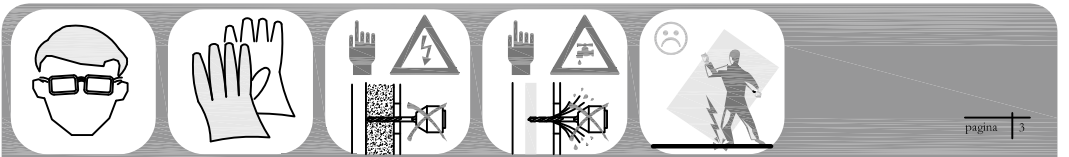

S13 2x	S14 1x	S15 2x	S16 2x	S17 L 1x R 1x
S18 6x	S19 8x	S20 11x	S21 6x	S22 1x
S23 1x	S27 2x			

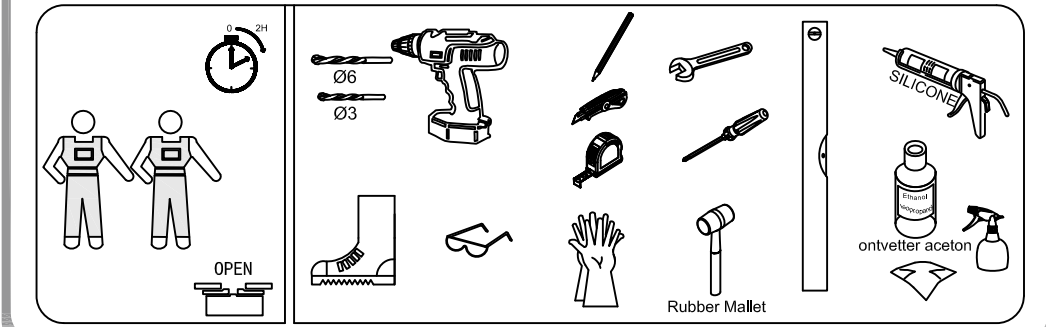

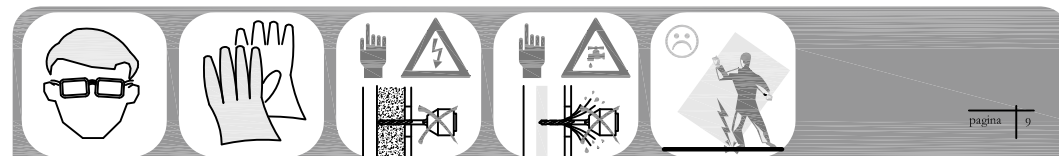
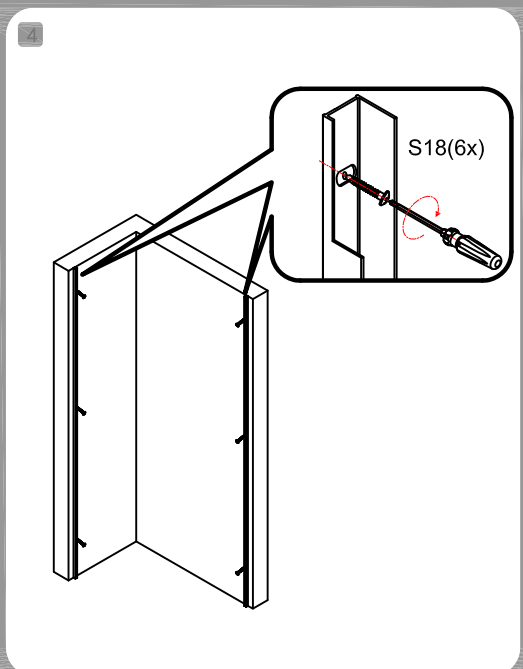
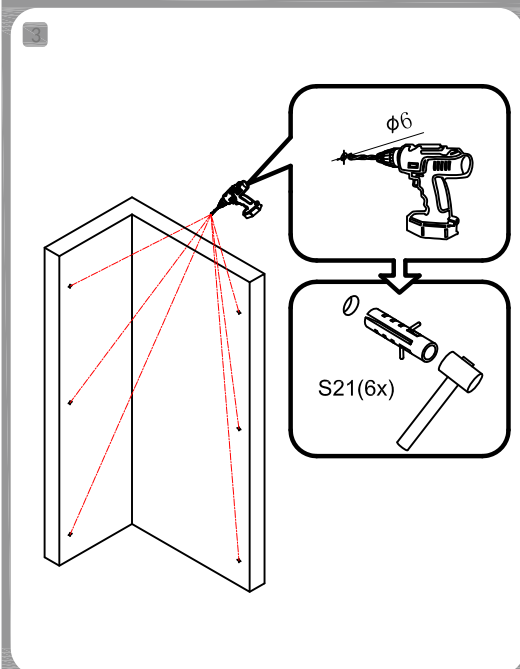
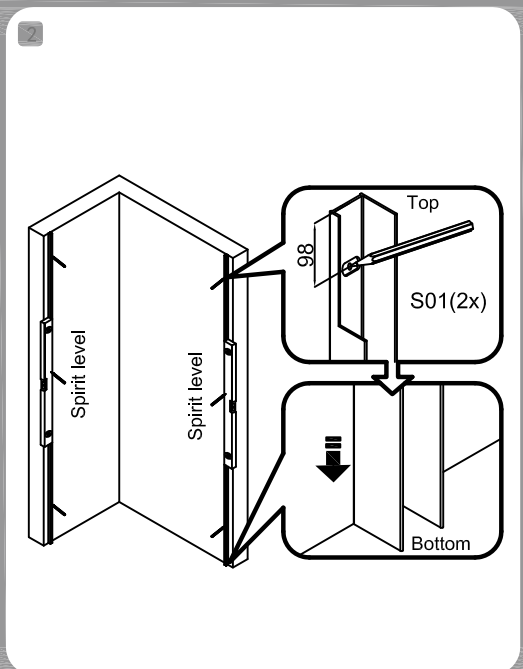
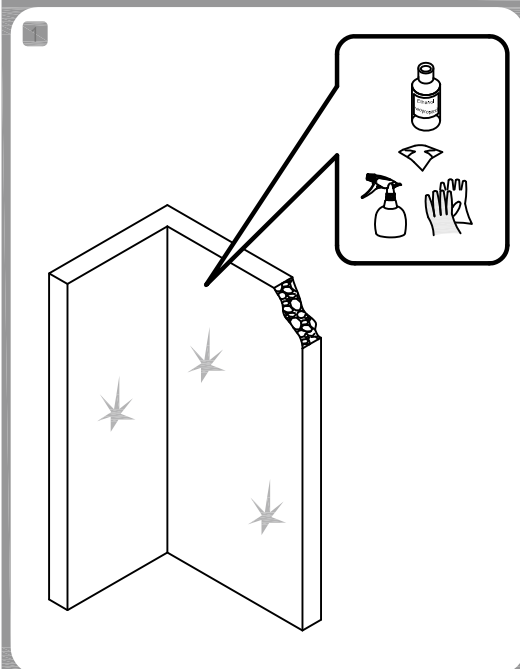

INSTRUCTIE VOOR GOED GEBRUIK EN ONDERHOUD

De douchewand moet na elk gebruik schoon gemaakt worden. Gebruik hierbij geen chemische middelen, maar een zachte doek of wisser. Gebruik nooit schuurmiddelen.

