Montageanleitung Schalldämmplatten-Set für Wand-WC und Wand-Bidet
Mounting instructions Noise reduction gasket for wall-mounted toilet and bidet
Notice de montage Set de protection acoustique pour WC et bidet suspendu
Montageaanwijzing Geluidsdempende montageset voor wand-wc en wand-bidet
Istruzioni di montaggio Set insonorizzante per tutti i vasi e bidets sospesi
Instrucciones de montaje Para la junta de reducción de ruido para inodoro y bidé suspendido
Instruções de montagem Redutor de ruído para bacias WC e bidés suspensos
Montaj kılavuzu Ses yalıtım contası
安装说明 挂壁式座便器及净身器减噪衬垫

0050200000

PRODUKTEIGENSCHAFTEN

- 100% recyclingfähig
- geruchsneutral
- beidseitig glatte Schäumhaut
- Verringerung der Störgeräusche
- Schalldämmgutachten

ANWENDUNG

Elastische Befestigungsplatte zur Unterbrechung von Schallbrücken zwischen Wandfliesen und hängenden Keramikobjekten.

Technische Verbesserungen und optische Veränderungen an den abgebildeten Produkten behalten wir uns vor.

PRODUCT CHARACTERISTICS

- 100% recyclable
- odourless
- bilateral foam skin
- noise reduction
- sound absorption certificate

APPLICATION

Elastic plate for interruption of noise bridges between tiles and wall-mounted ceramics.

We reserve the right to make technical improvements and enhance the appearance of the products shown.

CARACTERISTIQUES

- 100% recyclable
- inodore
- lisse des deux côtés
- diminution des bruits indésirables
- isolation acoustique

APPLICATION

Plaque de montage en matière élastique évitant le pont acoustique entre la paroi et l'appareil céramique suspendu.

Nous nous réservons le droit d'apporter des améliorations techniques et de modifier l'apparence visuelle des produits présentés.

PRODUKTEIGENSCHAFTEN

- 100% recycleerbaar
- geurloos
- dubbelzijdig glad oppervlak
- vermindering van storend geluid
- geluidsdempend

TOEPASSING

Elastische montageplaat ter verhinderen van geluidsoverdracht tussen wand en keramische ophangtoestellen.

Technische verbeteringen en optische wijzigingen ten opzichte van de afgebeelde producten voorbehouden.

CARATTERISTICHE DEL PRODOTTO

- 100% riciclabile
- inodore
- superficie piane in resina espansa
- riduzione dei fastidiosi rumori di sciacquo
- certificato d'insonorizzazione

APPLICAZIONE

Guarnizione elastica per la limitazione della propagazione dei suoni fra i sanitari sospesi e le piastrelle.

Con riserva di apportare modifiche tecniche.

CARACTERISTICA DEL PRODUCTO

- 100% reciclable
- neutro en olores
- ambos lados en espuma lisa
- reducción de ruidos
- Certificado de reducción de ruidos

APLICACIÓN

Una lámina flexible para la interrupción del puente acústico entre los azulejos y la cerámica suspendida.

Nos reservamos el derecho de realizar modificaciones técnicas y de aspecto de los productos representados.

CARACTERÍSTICAS DO PRODUTO

- 100% reciclável
- sem odor
- película de espuma bilateral
- redutor de ruído
- certificado de absorção de ruído

APLICAÇÃO

Placa elástica que interrompe o ruído entre os azulejos e a cerâmica..

Reservamo-nos o direito de efectuar melhorias técnicas e alterações visuais que beneficiem os produtos apresentados.

ÜRÜN ÖZELLİKLERİ

- 100% Yeniden değerlendirilebilir
- kokusuz
- İki yüzde de düz köpük yüzeyi
- Rahatsız edici seslerin azaltılması
- Ses yalıtım sertifikası

UYGULAMA

Elastik conta; seramik ile fayans arasında ses yalıtımı sağlamaktadır.

Belirtilen ürünlerinde teknik iyileştirme ve görsel değişiklik yapma haklarımız saklıdır.

产品特点:

- 100% 再循环
- 无嗅
- 两边泡沫外壳
- 噪声小
- 吸音性能

运用:

墙面与陶瓷产品间的弹性板,用于中断噪声传递。

由于技术改进,我们保留改变产品规格说明的权利。

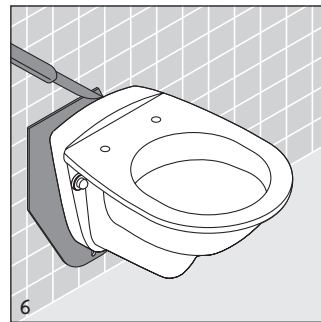
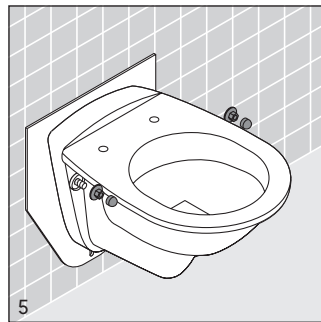
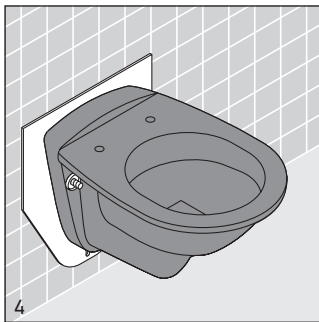
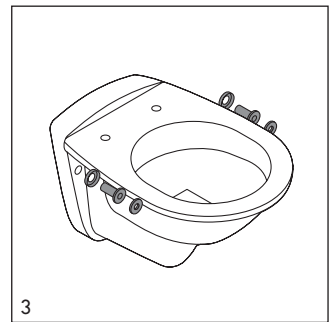
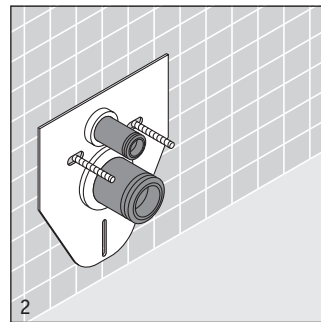
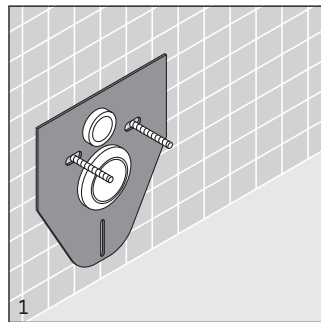
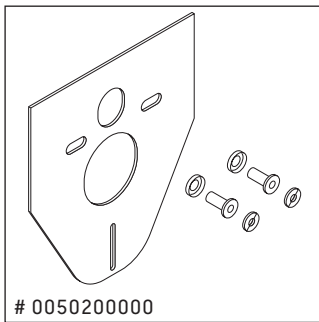

Duravit AG
Werderstr. 36
78132 Hornberg
Germany
Phone +49 78 33 70 0
Fax +49 78 33 70 289
info@duravit.de
www.duravit.de

