

# Installation Manual

Montageanleitung  
Instructions de montage  
Istruzioni per il montaggio

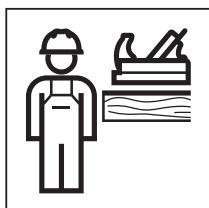

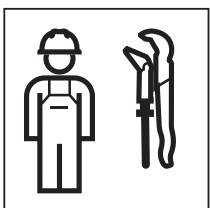

1

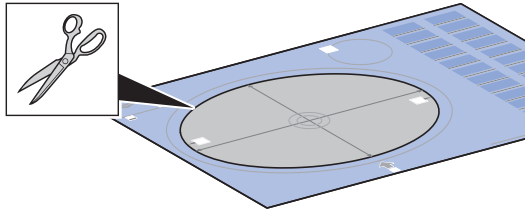

2

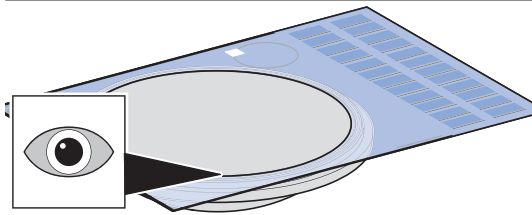
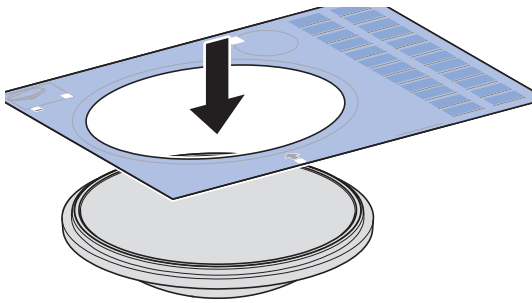

3

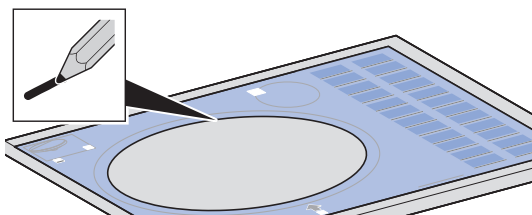
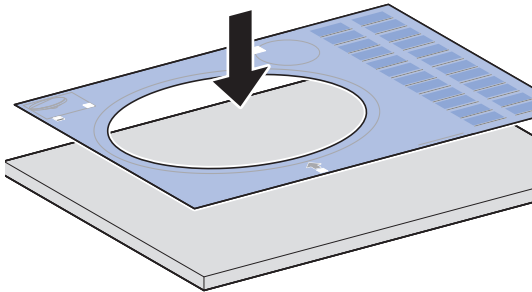

4

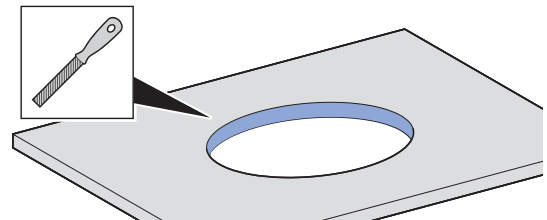
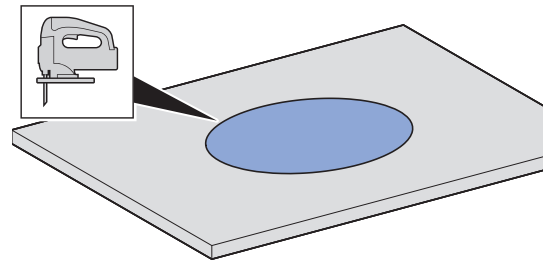
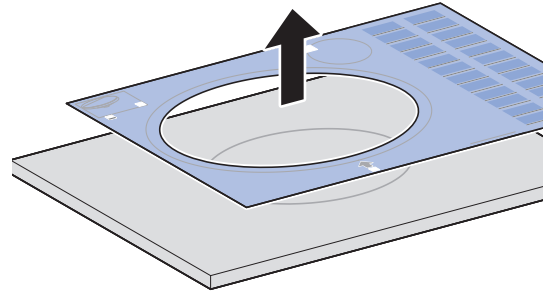

# 2

1

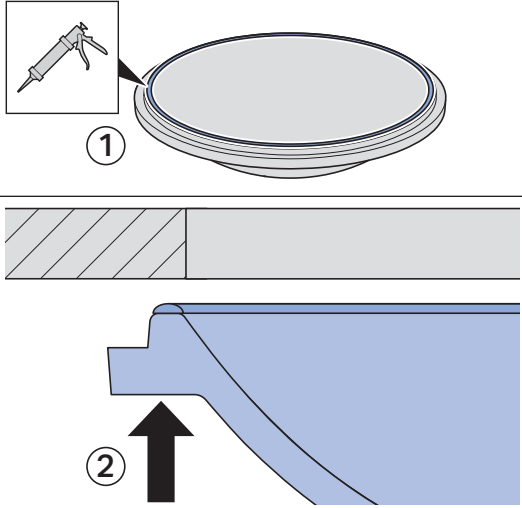

2

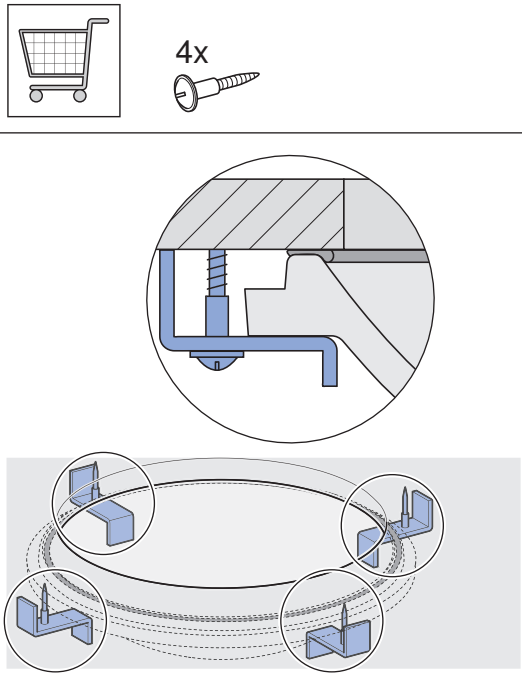

3

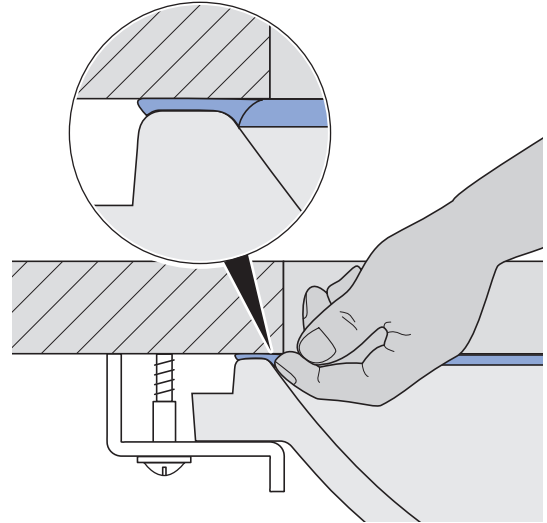

4

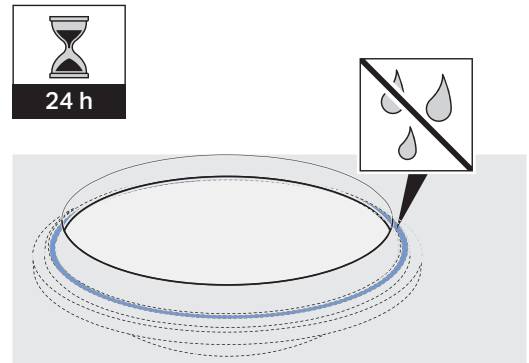

---

**Geberit International AG**  
Schachenstrasse 77, CH-8645 Jona  
documentation@geberit.com  
→ [www.geberit.com](http://www.geberit.com)

