

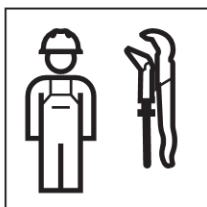

# Installation Manual

Montageanleitung  
Instructions de montage  
Istruzioni per il montaggio

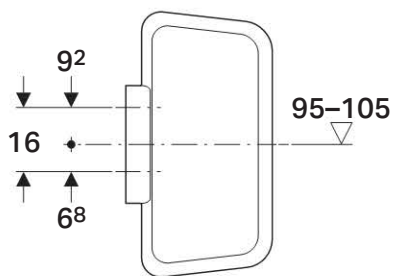

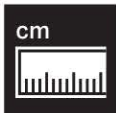

1

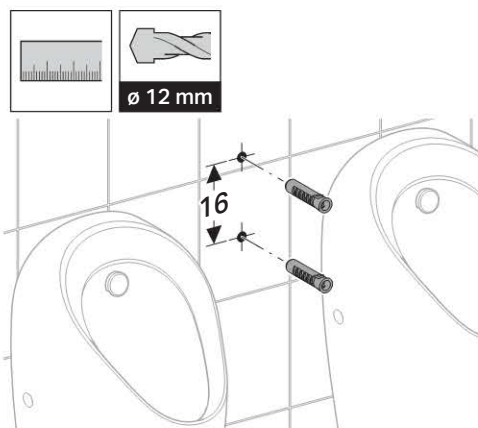

2

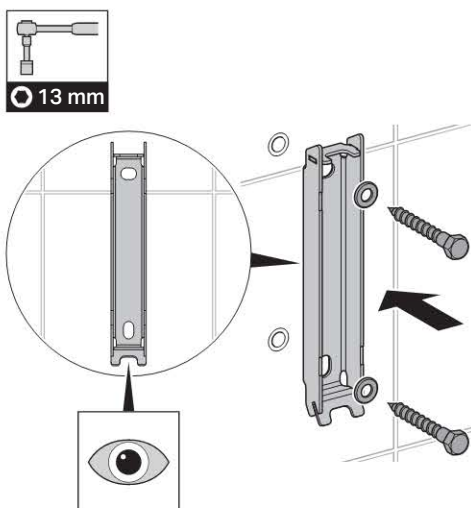

3

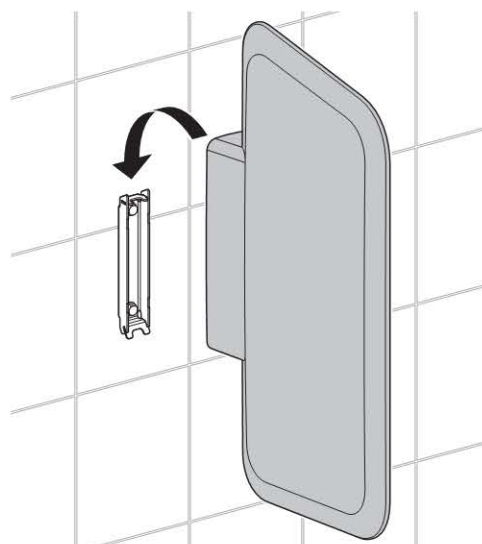

4

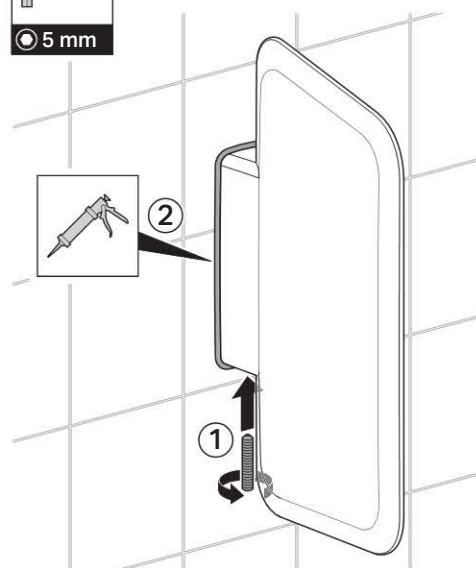

Geberit International AG, Schachenstrasse 77, CH-8645 Jona  
T +41 55 221 63 00  
F +41 55 221 63 16  
documentation@geberit.com  
→ www.geberit.com